

HITCH MOVER - HM-B2516

APPROX WEIGHT: 43.01 lbs.
DOES NOT INCLUDE WEIGHT OF POWER OR PACKAGING!!!

*** ANY ADDITIONS, DELETIONS, OR OMISSIONS MUST BE CORRECTED ON THIS DRAWING AS THIS DRAWING WILL BE CONSIDERED ALL INCLUSIVE ***

ALL GRAPHICS PROVIDED ARE FOR REFERENCE ONLY. IF CERTAIN DIMENSIONS ARE CRITICAL PLEASE VERIFY THOSE DIMENSIONS WITH YOUR SALESPERSON

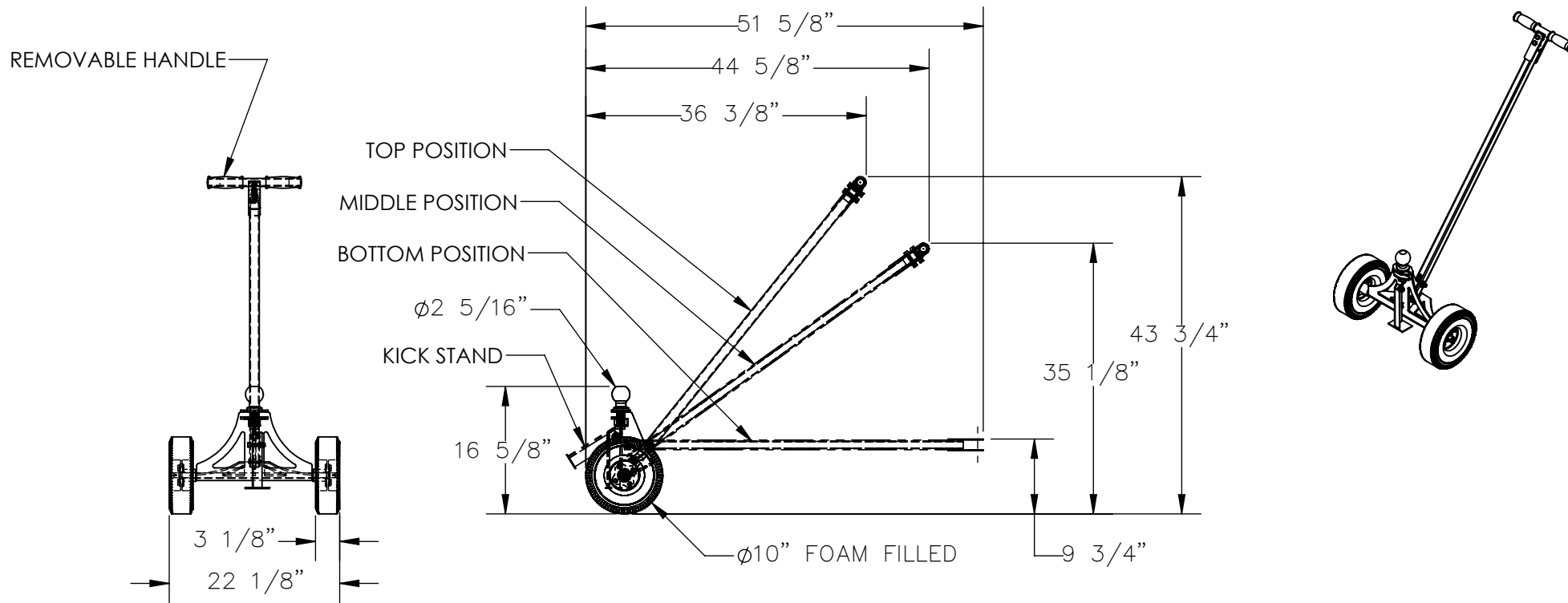

DIMENSION TOLERANCE ± 1/4"

STANDARD FEATURES

- MODEL NUMBER IS: HM-B2516
- CAPACITY IS: 1,000 LBS
- OVERALL WIDTH IS: 22 1/8"
- OVERALL LENGTH IS: 36 3/8" - 51 5/8"
- REMOVABLE HITCH BALL IS: Ø2 5/16"
- HANDLE HEIGHT IS ADJUSTABLE FROM: 9 3/4" - 43 3/4"
- WHEELS ARE: 3 1/8" X 10"
- HANDLE ARM IS: 3-POSITION ADJUSTABLE
- HANDLE ARM TOP & MIDDLE POSITION FOR MANUAL MOVING OF LOADS
- HITCH MOVER IS TOWABLE IN BOTTOM POSITION W/ HANDLE REMOVED
- STORE HITCH MOVER UPRIGHT WHEN HANDLE IS IN MIDDLE POSITION W/ INCLUDED KICKSTAND
- TOUGH BAKED IN POWDER COATED BLUE FINISH

SPECIAL FEATURES

NONE

APPROVAL

I, THE UNDERSIGNED, AGREE THAT THE PRODUCT AS REPRESENTED SATISFIES DESIGN AND DIMENSION REQUIREMENTS. I ALSO ACKNOWLEDGE MY DUTY TO CONFIRM PRODUCT AND INSTALLATION COMPLIANCE WITH ALL APPLICABLE FEDERAL, STATE AND LOCAL REGULATIONS AND STANDARDS.

UNITS REQUIRING APPROVAL DRAWINGS OR MODIFIED ARE NON-RETURNABLE

As drawn As marked

Signed: _____ Date: _____

Printed Name: _____

LEAD TIME WILL START UPON RECEIPT OF SIGNED APPROVAL DRAWING

DISTRIBUTOR'S NAME:		P.O.#
VESTIL MANUFACTURING		X
DRAWN BY: JGP		W.O.#
DATE: 3/3/2021		X
REFERENCE: X	SCALE: 1:20	SALES: X
QUOTED LEAD TIME: X	QUOTE #	FILE NAME:
	X	16-007-530